

HiOazo

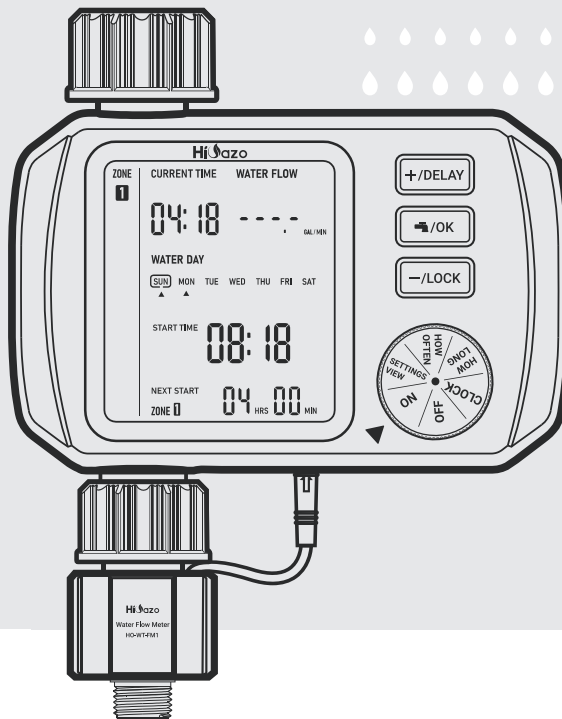

WATER TIMER USER MANUAL

HO-WT-1



Scan to

download



Scan To View the Setup Video
Escanear para descargar el manual
Scansione per scaricare il manuale
Scannen, um das Handbuch herunterzuladen

Please keep this manual properly for reference. You can also scan the QR code below to visit our official website for product usage videos. For any usage issues, please feel free to contact us at support@inkbird.com.

CONTENTS

01 <i>Overview</i>	01
02 <i>Technical Specifications</i>	01
03 <i>Product Introduction</i>	02
04 <i>Important Notes/Warning</i>	06
05 <i>Installation Instructions</i>	07
06 <i>Operation Instructions</i>	11
07 <i>Troubleshooting Guide</i>	22
08 <i>FCC Requirements</i>	24
09 <i>Customer Service</i>	25
10 <i>Watering Plan Form</i>	25



01 Overview

HiOazo HO-WT-1 Water Timer enables your water faucet to automatically water your plants according to your preset schedule, freeing you from your daily routine to deal with more important things. Better than manual watering, this water timer features a soaking function that allows water to permeate the soil, which is more beneficial to plant growth. And, with the rain delay function, it will postpone the watering schedule on rainy days, saving water and money. HO-WT-1 Water Timer meets your daily watering needs for your garden, lawn, courtyard and more.



02 Technical Specifications

Product Name	Single-outlet Water Timer
Model Number	HO-WT-1
Power Source	2 AA (1.5V) Alkaline Batteries (not included)
Working Pressure	15~145psi/1.0~10Bar
Waterproof Level	IP54
Working Temperature	1°C~60°C/34°F~140°F
Rain Delay	24 hours/48 hours /72 hours
Screen Type	LCD with Backlight
Watering Mode	Interval Day Mode (Every 1~30 Days)/Day of the Week Mode
Watering Duration	1 minute~23 hours and 59 minutes
Water Inlet	US NH3/4"-11.5; EU G1 or G3/4-15
Hose Adapter Outlet	3/4" Standard Hose
Product Warranty	2 Years



03 Product Introduction



Water Timer

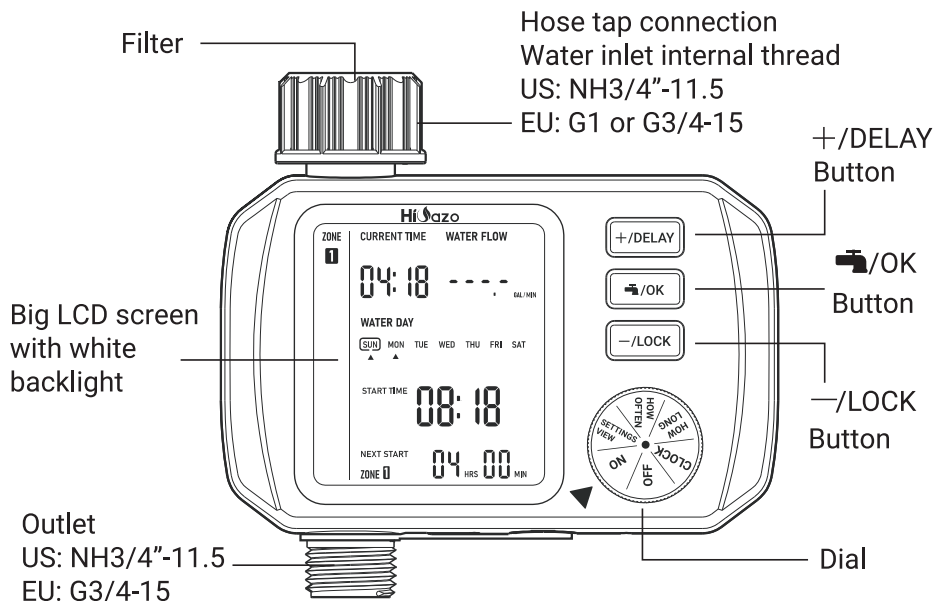



Key Definitions

Button	Function
+ /DELAY	Increase parameters; When the Dial turns to ON, short-press to turn on/off the rain delay function; press and hold for 2 seconds to enter/exit the setting of rain delay time.
 /OK	Confirm setting; When the Dial turns to ON, short-press to enter manual mode. In the Manual mode, short-press to open the control valve, short-press again to close and return to automatic mode.
- /LOCK	Decrease parameters; When the Dial turns to ON, press and hold for 2 seconds to enable/disable Child Lock.
CLOCK	Set the current time and day.
HOW LONG	Turn on/off watering plans P1/P2/P3 and set start time/end time/soaking time/watering time.
HOW OFTEN	Set how often to water your plant, in Interval Day Mode or Day of the Week Mode
SETTINGS VIEW	View details of the watering plans you set.
ON	Enter automatic mode or manual mode.
OFF	Turn off the water timer and stop all watering plans.



LCD

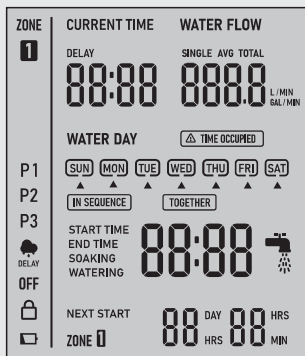

LCD Icon	Function
P1/P2/P3	Watering plans P1,P2,P3
DELAY	Rain Delay Function ON/OFF state
OFF	OFF Mode
	Child Lock
	Low battery indicator
DELAY	Rain Delay Setting State
WATER FLOW SINGLE AVG TOTAL 0000 L/MIN 0000 GAL/MIN	Water flow meter data; Depending on the selected unit, displays --.-G/MIN -> --.-SINGLE/G -> --AVG/G -> --.-TOTAL/G or--.-L/MIN -> --.-SINGLE/L -> --.-AVG/L -> --.-TOTAL/L in turns every 3 seconds. SINGLE means single watering data, refreshing every minute, and until the next watering action, it will start clearing to zero; AVG means the average water flow of the last 7 days (excluding today); TOTAL means the total water flow.
(SUN)	The selected day of the week
SUN ▲	The selected day for watering
△ TIME OCCUPIED	Lights up when Soaking time + Watering time > End Time – Start Time, indicating that the setting time is incorrect.
	Lights up when watering
NEXT START ZONE 1 08 DAY 08 HRS	Prompt for the next watering day



Water Flow Meter (optional)

After connecting a water flow meter, the screen will display water flow speed, single water flow, the average water flow of the last 7 days (excluding today), and total water flow in turns. When the water flow meter is disconnected or no data exit, the screen will display the character - - - - .

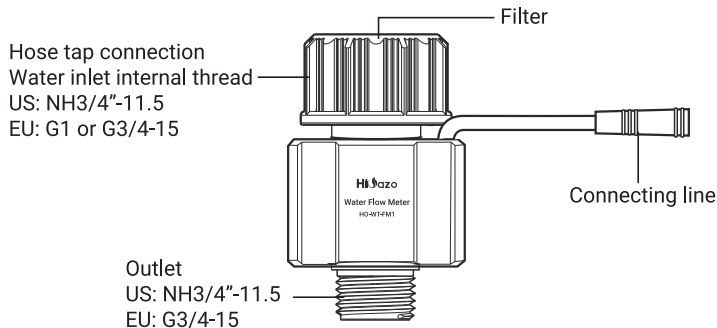

Model Number	HO-WT-FM1
Water Flow Range	0.5~9.2GAL/min (2~35L/min)
Accuracy Error	Regular 5%

Usage Tips:

1. To ensure the accuracy of the water flow meter, it should be installed horizontally or upward in the water pipe.
2. To avoid impurities entering the sensor, the filter should be installed at the front end of the straight tube of the water flow meter.
3. If any magnetic material or material that generates a magnetic force on the sensor goes close to the sensor, it may change the characteristics of the sensor.



Hose Adapter

- US: NH3/4-11.5
- EU: G3/4-15

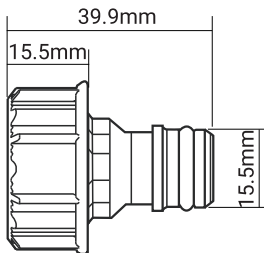
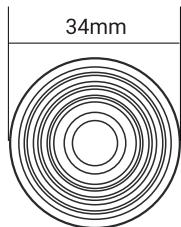

04 Important Notes/Warning

1. Don't use the water timer when the temperature is below 37°F (3°C), and please store the timer indoors to avoid potential freezing damage.
2. The filter traps dirt particles, preventing them from entering the timer and causing clogging. Please clean the filter regularly and replace it if worn.



Filter Dismounting Steps

- The filter is installed correctly at the factory. You can dig it out for cleaning if needed.

- When installing it, please follow the steps below to install it correctly and keep it tidy.

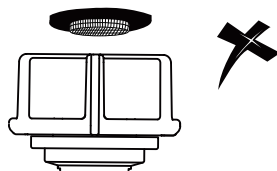
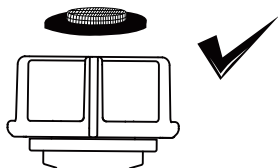

3. To ensure a longer lifespan, please use 2 new AA alkaline batteries (need to purchase separately). Do not mix using new and old alkaline batteries together. Please use alkaline batteries and do not use standard (carbon-zinc), or rechargeable (nickel cadmium) batteries.

4. When the timer is not used for a long time, please remove the batteries and dispose of them properly.

5. Only use clean cold water.



05 Installation Instructions



Battery Installation

- Open the battery cover on the back of the water timer.
- Install 2 AA 1.5V alkaline batteries(not included).
- Replace the battery cover and press it firmly to ensure it is fully installed for waterproof protection.

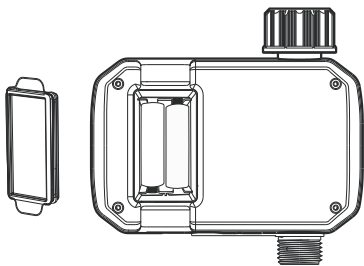

Tips:

- When the low battery indicator lights up, the water timer will stop watering to avoid water leakage. In the meantime, the batteries should be replaced timely to continue your watering schedule.
- To ensure a longer lifespan, please use 2 new AA alkaline batteries (need to purchase separately). Do not mix using new and old alkaline batteries together. Please use alkaline batteries and do not use standard (carbon-zinc), or rechargeable (nickel cadmium) batteries.
- When low power, please replace the batteries to avoid the interruption of normal operation.
- When replacing the batteries, please make sure that the battery tray is dry.

6 Water Flow Meter Installation (optional)

- Make sure the filter is clean and installed correctly.
 - Install the water flow meter on the water outlet of the timer.
 - Open the silicone cover of the water flow meter connection port at the bottom of the timer.
- Firmly insert the water flow meter into the port.

Tip: If the water flow meter is not inserted, the connection port should be well-covered to prevent water from entering the water timer.

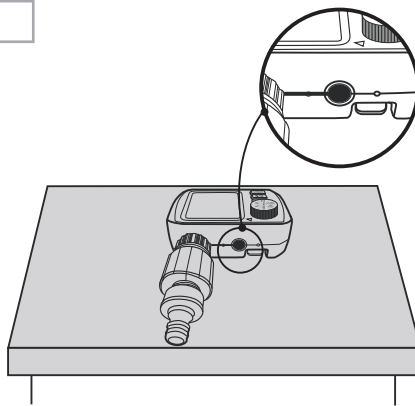



Water Timer Installation

- Please turn off the water faucet first.
- Make sure the filter is clean and installed correctly.
Screw the water timer onto the water faucet horizontally or vertically. The slope cannot be over 15 degrees.
- Screw the hose to the outlet of the water timer.
- Turn on the water faucet and check for water leaks.

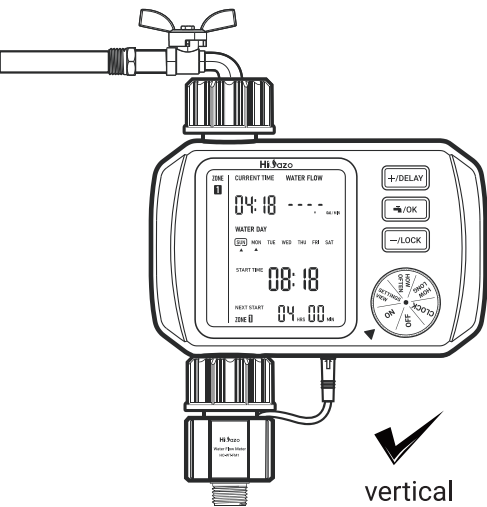

Note: Please insert it firmly until the front end of the arrow enters the jack.

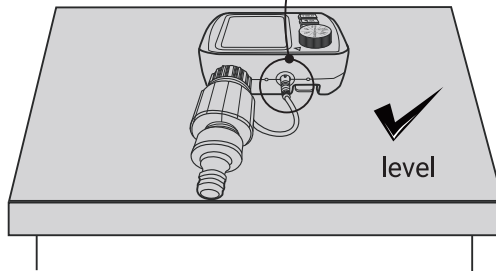
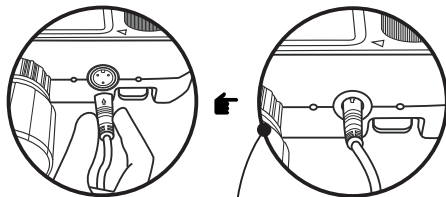

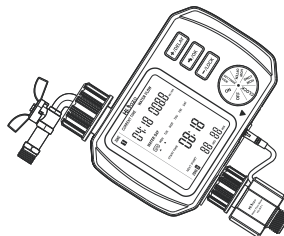
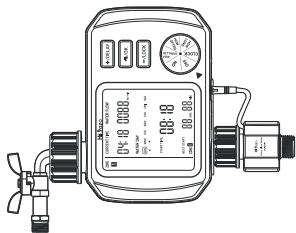

Tips: If the connection between the timer and the faucet or hose is not tight or leaking occurs, wrap more Teflon Tape (Thread seal tape) to make them tight.

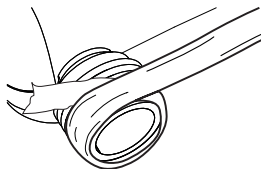

Before setting, check if the device works properly

- Before use, please check whether the device can control the water valve and whether the watering equipment works properly.
- Please repeat **the Manual Watering** on page 18 for 2 to 3 times according to the Operation Instructions to confirm whether the device works properly.

Note: When testing, please stay away from the water outlet of the device to avoid being splashed by water.



06 Operation Instructions

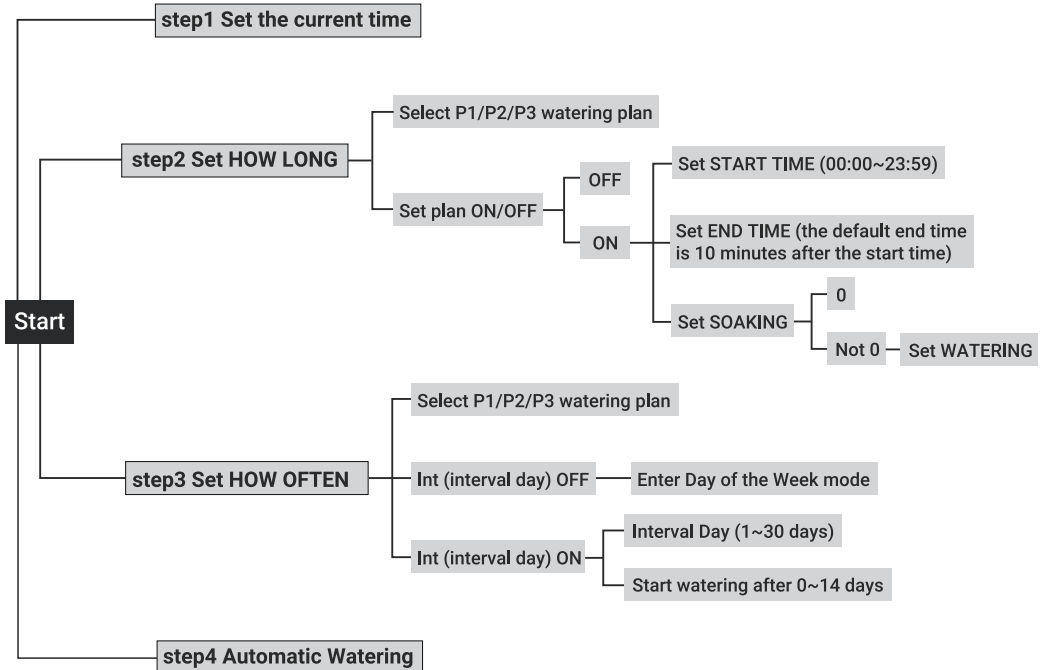



SET CLOCK (24-hour format only)

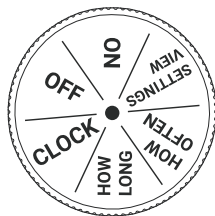
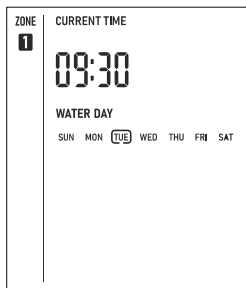

Step1: Turn the dial to **CLOCK**, and the hour of the current time will flash. Press the **+ / DELAY** or **- / LOCK** to adjust the number, then press the **OK** to confirm.

Step2: Set the minutes, and the minute of the current time will flash. Press the **+ / DELAY** or **- / LOCK** to adjust the number, then press the **OK** to confirm.

Step3: Set the day, and the icon **TUE** will flash. Press **+ / DELAY** or **- / LOCK** to select the day of the week, then press **OK** to confirm.

Step4: Turn the dial to another position to save the setting.

Tips:

- Long-press the **+ / DELAY** or **- / LOCK** to quickly adjust the parameter value.
- Comparison chart of 12-hour clock and 24-hour clock.

24-hour clock	12-hour clock
00:00	12:00 midnight/12:00a.m.
01:00	01:00 a.m.
02:00	02:00 a.m.
03:00	03:00 a.m.
04:00	04:00 a.m.
05:00	05:00 a.m.
06:00	06:00 a.m.
07:00	07:00 a.m.
08:00	08:00 a.m.
09:00	09:00 a.m.
10:00	10:00 a.m.
11:00	11:00 a.m.
12:00	12:00 noon/12:00 p.m.
13:00	01:00 p.m.
14:00	02:00 p.m.
15:00	03:00 p.m.
16:00	04:00 p.m.
17:00	05:00 p.m.
18:00	06:00 p.m.
19:00	07:00 p.m.
20:00	08:00 p.m.
21:00	09:00 p.m.
22:00	10:00 p.m.
23:00	11:00 p.m.
24:00	12:00 midnight/12:00 a.m.

Set HOW LONG (PLAN ON/OFF, START TIME, END TIME,SOAKING,WATERING)

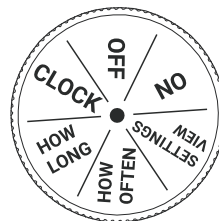
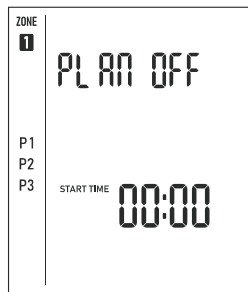

LCD ICON	Function
PLAN ON	The watering plan is turned on.
PLAN OFF	The watering plan is turned off.
START TIME	Start time (00:00~23:59, set in 24-hour format); 00:00 means HH:MM
END TIME	End time (00:00~23:59, set in 24-hour format); (the default end time is 10 minutes after the start time); 00:00 means HH:MM If the END TIME is earlier than the START TIME, the watering will proceed to the next day.
SOAKING	Soaking time (00:00~23:59, set in 24-hour format); Please set a time less than START TIME – END TIME ; 00:00 means HH:MM
WATERING	Watering time (00:00~23:59, set in 24-hour format); Please set a time less than START TIME – END TIME ; 00:00 means HH:MM

Notes:

- If the **SOAKING** time is set to 0, there is no need to set the **WATERING** time, and watering will be performed from the start time to the end time.
- If the **SOAKING** time is set to a value other than 0, then the **WATERING** time needs to be set. And the total time of **SOAKING + WATERING** cannot be greater than the result of **END TIME - START TIME**. Otherwise, the screen will prompt  **TIME OCCUPIED** .



Time Setting:



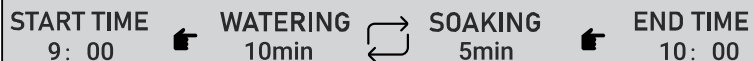



SOAKING + WATERING < END TIME - START TIME







- Watering begins at the **START** time, pauses at the **SOAKING** time, continues at the **WATERING** time, then repeats the **SOAKING-WATERING** pattern until the **END** time, as shown below.







Step1: Turn the dial to **HOW LONG**, press the  or  to select the plan to be set, which will flash. Then press the  button to confirm.







Step2: Enter the setting of plan ON/OFF and the relevant parameter will flash. Press the  or  turn on/off the selected plan, then press the  button to confirm.

Step3: Enter **START TIME** setting, and the hour parameter will flash. Press the  or  to adjust the number, then press the  to confirm and set the minute value. Press the  or  to adjust the number, then press the  to confirm.

Step4: Enter **END TIME** setting, and the hour parameter will flash. (The default end time is 10 minutes after the start time) Press the  or  to adjust the number, then press the  to confirm and set the minute value. Press the  or  to adjust the number, then press the  to confirm.

Step5: Enter **SOAKING** time setting, and the hour parameter will flash. Press the  or  to



adjust the number, then press the /OK to confirm and set the minute value. Press the /DELAY or /LOCK to adjust the number, then press the /OK to confirm.

Step6: Enter **WATERING** time setting, and the hour parameter will flash. Press the /DELAY or /LOCK to adjust the number, then press the /OK to confirm and set the minute value. Press the /DELAY or /LOCK to adjust the number, then press the /OK to confirm.

Note: When **SOAKING** time is set to 00:00, pressing the /OK will return to step 1.

Step7: Turn the dial to another position to save the setting.

Tip:

- Long-press the /DELAY or /LOCK to quickly adjust the parameter value.
- Changing the ON/OFF status of the P1/P2/P3 plan will not change the relevant parameters.

 **Set HOW OFTEN (Day of the Week Mode/Interval Day Mode)**

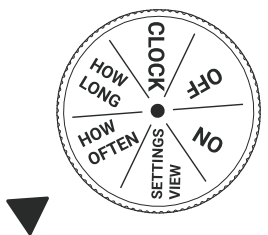
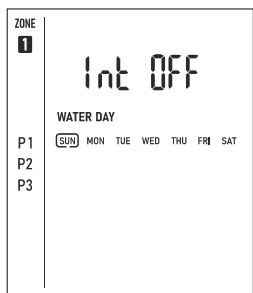

LCD ICON	Function
Int OFF	Interval Day mode is turned off and enters Day of the Week mode.
Int ON	Interval Day mode is turned on.
SUN ▲	The selected day of the water day.
EVER	Every: Set to water every 1~30 days.
AFTER	After: Set to start watering after 0~14 days; 0 means starting today.

Step 1: Turn the dial to **HOW OFTEN**, press the **+ / DELAY** or **- / LOCK** to select the plan to be set, which will flash, then press the **OK** to confirm.

Step 2: Enter watering mode setting, and the relevant parameter will flash. Press the **+ / DELAY** or **- / LOCK** to select a mode, then press the **OK** to confirm.

Step 3: Two modes to choose:

Day of the Week Mode (Int OFF): to water on the selected day of the Week.

Interval Day Mode (Int ON): to water every 1~30 days.

Step 3-1: Select **Day of the Week mode (Int OFF)**, press the **+ / DELAY** or **- / LOCK** to move the cursor to choose a watering day, then press the **OK** to confirm. When the cursor is on SAT, press the **+ / DELAY** to return to step2.

Step 3-2: Select **Interval Day mode (Int ON)**, and the screen will display the character **E U E r** (Every), and the relevant parameter will flash. Press the **+ / DELAY** or **- / LOCK** to set interval days, then press the **OK** to confirm and select when to start watering. The screen will display the character **A F t A** (After), and the relevant parameter will flash. Press the **+ / DELAY** or **- / LOCK** to adjust the number, then press the **OK** to confirm.

Step 4: Turn the dial to another position to save the setting.

Tips:

- How to switch to the Day of the Week mode?
When OFF is selected for Int, the timer will run in Day of the Week mode.
- How to set it to water every day?
 - a. Enter the Day of the Week mode (Int OFF), select each day of the week.
 - b. Enter the Interval Day mode (Int ON), set 1 on Every and 0 on After.
- Three watering plans can be turned on/off independently, with independent watering frequency, start time, end time, soaking time, and watering time.



SETTINGS VIEW

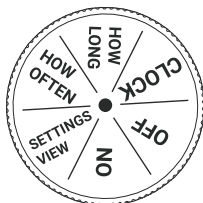
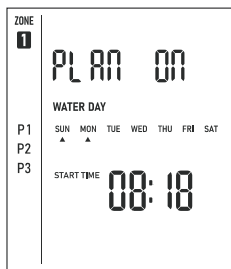

Step 1: Turn the dial to **SETTINGS VIEW**.

Step 2: Press the **+ / DELAY** to select P1/P2/P3 watering plan.

Step 3: Press the **- / LOCK** to view the details of the selected plan.



Automatic Watering

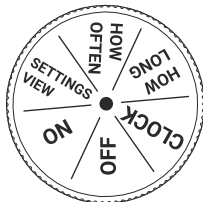
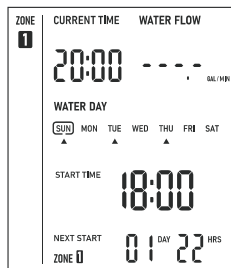

Step 1: Turn the dial to **ON**.

Step 2: The LCD shows the current time, start time, and next watering day.

Tips: When the **SOAKING** time is set to 0, the screen will display **END TIME** instead of **START TIME**. When the **SOAKING** time is set to a value other than 0, it will display the soaking time countdown during soaking and the watering time countdown during watering.



Manual Watering

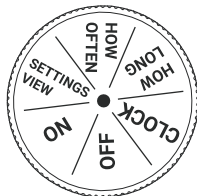
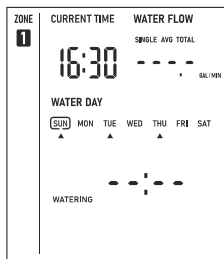

Step 1: Turn the dial to **ON**, and press the /OK to enter the manual watering time setting. When the screen displays - -: -, it means that the manual watering time is unlimited.

Step 2: Press the or to adjust the watering time.

Step 3: Press the /OK to exit the setting and start manual watering. The screen will display the character **WATERING** and the remaining watering time.

Step 4: After/during manual watering, press the /OK to turn off the manual watering action and return to the automatic watering mode.

Note:

- When the **WATERING** time is set to - -: -, it means the manual watering time is unlimited.
- During manual watering, users can press the or to adjust the watering time.



Rain Delay Function

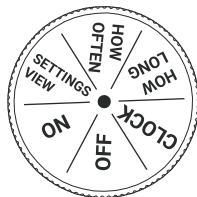

Step 1: Turn the dial to **ON**, press and hold the for 2 seconds, and the screen will display the character DELAY and the related delay time.

Step 2: Press the or to adjust the delay time.

Step 3: Press and hold the for 2 seconds to save and quit the setting and to execute the rain delay action.

Note:

Turn the dial to **ON**, then press the **+/DELAY** to execute or cancel the rain delay action.

Execute the rain delay action:

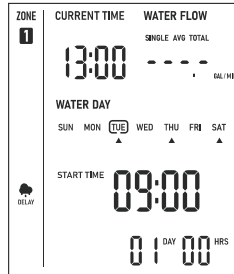

OFF Mode

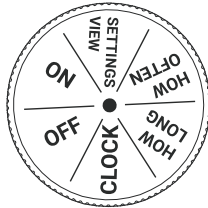
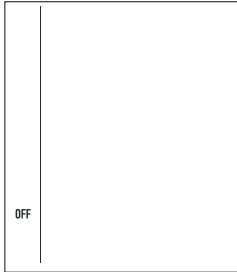

Turn the dial to **OFF**, the screen will only display the character **OFF**, and the timer will stop all watering plans and actions.



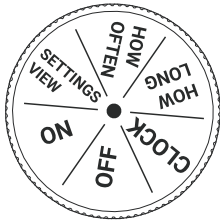

Child Lock Function

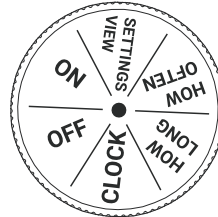

OR



Turn the dial to **ON** or **OFF**, then press and hold the  for 2 seconds to turn on/off the child lock. In this state, the operation of the dial or any button will not trigger any action. Users can turn the dial to any position, then press and hold the  for 2 seconds to turn off the child lock function.

When the child lock function is turned on, the display is as follows:

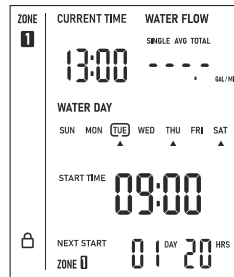

Reset All Parameters

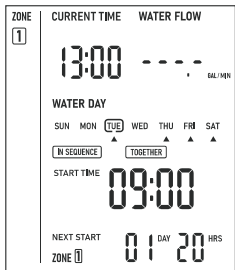

Turn the dial to **ON**, then press and hold the **OK** for more than 5 seconds to reset all parameters and clear the water flow meter data.

Switch the Display Unit of the Water Flow Meter

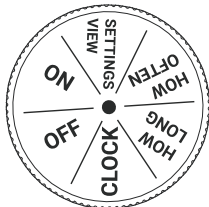
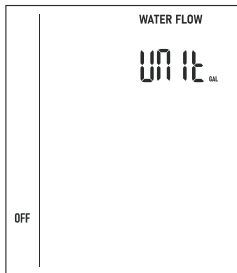

LCD ICON	Function
UNIT	UNIT; Switch display units between GAL and L.

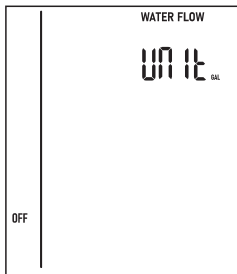

Step 1: Turn the dial to **OFF**, and press and hold the **OK** for 2 seconds. The screen will display the characters WATER FLOW and UNIT (UNIT) and the unit parameter of the water flow meter will flash.



Step 2: Press the **+ / DELAY** or **- / LOCK** to select the water flow meter display unit, GAL or L.

Step 3: Press and hold the **+ / DELAY** for 2 seconds or no operation for 20 seconds to exit the setting and save the parameters. You can also turn the dial to another position to exit and save parameters.



07 Troubleshooting Guide

What can you do if the device is not working? Here are some possible reasons and relative solutions for reference. We hope they are helpful. For any further questions, please feel free to contact us at support@ink-bird.com.

Problem	Possible Causes	Possible Solution
No Power	Low Battery / Battery Damage	Check if the battery status icon  lights up on the screen. If the battery is low, replace the battery.
	Incomplete Battery Installation	Open the battery cover, reinstall the batteries, and press down on the cover firmly.
	Incorrect Battery Installation	Reinstall the batteries.
Equipment Not Watering	Water Tap Not Turned On	Turn on the water tap.
	Filter Clogged	Disassemble the water timer, then check and clean the filter.
	Low Water Pressure	Check the water pressure and make sure it's over 15PSI.
	Water Plan Unprogrammed	Check the water plan parameters and make sure they are correctly set.
Equipment Not Turning Off Watering	Low Battery	See the LCD screen and check that the battery status icon  lights up.
	Abnormal Clock	See the LCD screen and check that the time is running normally.
Equipment Water Outlet & Hose Leakage	Rubber Gasket/ Filter Missing	Make sure the rubber gasket/filter is inserted and tightened to the inlet. Reinforce with waterproof tape if necessary.
Device Water Inlet Leakage	Filter Clogged	Turn the dial to ON to enter manual watering mode, and turn it off after ten seconds. Repeat several times if necessary.
Displaying  TIME OCCUPIED	Wrong Soaking/Watering Time Setting	Adjust soaking and watering times according to the time range from start time to end time.
Screen Blackout	Working Temperature Too High	Shade the device from the sun to cool it down, and it will resume working normally.
CURRENT TIME - - : - -	Clock Abnormality	Remove the battery and restart it. If the problem persists, please contact us.
LCD shows all and flashes	Water Leak Reminder	Please turn off the water source in time and contact us.



08 FCC Requirements

Changes or modifications not expressly approved by the party responsible for compliance could void the user's authority to operate the equipment. This device complies with Part 15 of the FCC Rules. Operation is subject to the following two conditions:

- (1) this device may not cause harmful interference, and
- (2) this device must accept any interference received, including interference that may cause undesired operation.

Note: This equipment has been tested and found to comply with the limits for a Class B digital device, pursuant to Part 15 of the FCC Rules. These limits are designed to provide reasonable protection against harmful interference in a residential installation. This equipment generates, uses, and can radiate radio frequency energy, and if not installed and used in accordance with the instructions, may cause harmful interference to radio communications. However, there is no guarantee that interference will not occur in a particular installation. If this equipment does cause harmful interference to radio or television reception, which can be determined by turning the equipment off and on, the user is encouraged to try to correct the interference by one or more of the following measures:

- Reorient or relocate the receiving antenna.
- Increase the separation between the equipment and receiver.
- Connect the equipment into an outlet on a circuit different from that to which the receiver is connected.
- Consult the dealer or an experienced radio/TV technician for help.

This equipment complies with FCC radiation exposure limits set forth for an uncontrolled environment. This equipment should be installed and operated with a minimum distance of 20cm between the radiator & your body. This transmitter must not be co-located or operating in conjunction with any other antenna or transmitter.



09 Customer Service

This item carries a 2-year warranty against defects in either components or workmanship. During this period, products that prove to be defective will, at the discretion of HiOazo, be either repaired or replaced without charge. For any problems in use, please feel free to contact us at support@inkbird.com. We will do our best to help you.



10 Watering Plan Form

PLAN	ON/OFF	WATER DAY	START TIME	END TIME	SOAKING	WATERING
P1		<input type="checkbox"/> Day of the Week Sun. Mon. Tus. Wed. Thu. Fri. Sat.	---:--	---:--	---:--	---:--
		<input type="checkbox"/> Every ___ days				
P2		<input type="checkbox"/> Day of the Week Sun. Mon. Tus. Wed. Thu. Fri. Sat.	---:--	---:--	---:--	---:--
		<input type="checkbox"/> Every ___ days				
P3		<input type="checkbox"/> Day of the Week Sun. Mon. Tus. Wed. Thu. Fri. Sat.	---:--	---:--	---:--	---:--
		<input type="checkbox"/> Every ___ days				