

INKBIRD

*Wireless
Temperature
Humidity
Sensor with
WiFi Gateway*



USER MANUAL

Scan to Download the Manual



Please keep this manual properly for reference. You can also scan the QR code below to visit our official website for product instructions. For any usage issues, please feel free to contact us at support@inkbird.com.

01 *Overview*

This combination of ITH-20R-O Wireless Temperature-Humidity Sensor and IBS-M2S WiFi Gateway allows you to remotely monitor the sensor temperature and humidity through gateway networking, check historical data and receive timely alarm notifications.

02 *Technical Specifications*

IBS-M2S WiFi Gateway (receiver) :

- Input Voltage: AC 100~240V 50/60Hz
- Maximum Wireless Connection Distance: up to 300 feet without interferences (Interferences will limit transmission)
- Number of ITH-20R-O Sensors Supported: up to 10 sensors at the same time

ITH-20R-O Wireless Sensor (transmitter) :

- Battery: 2* AAA 1.5V
- Transmission Distance: up to 300 feet without interferences
(Interferences will limit transmission)
- Temperature Measurement Range: -40°C~70°C (-40°F~158°F)
- Temperature Display Accuracy: 0.1°C (0.1°F)
- Temperature Measurement Accuracy: $\pm 0.3^{\circ}\text{C}$ ($\pm 0.5^{\circ}\text{F}$)
- Humidity Measurement Range: 0% ~100%
- Humidity Measurement Accuracy: $\pm 3\%$
- Humidity Display Accuracy: 0.1%
- Temperature-Humidity Sampling Period: 10 sec
- Warranty: 1 year

03 *Product Diagram*

IBS-M2S WiFi Gateway



ITH-20R-O Wireless Sensor

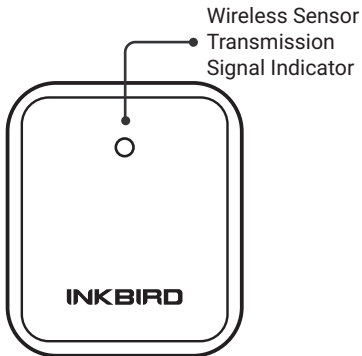

04 Key Definitions

IBS-M2S WiFi Gateway

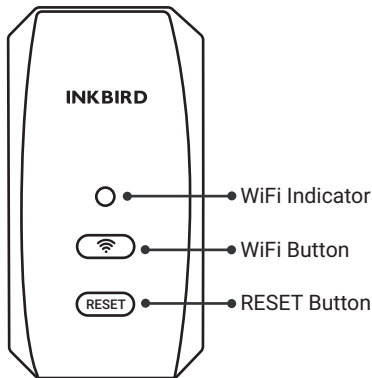

WiFi Button:

Press and hold the WiFi button for more than 5 seconds to reset WiFi and pair it with the network again.

Reset Button:

Press and hold the Reset button for more than 5 seconds to reset the registration of all sensors. The user should take out the battery of the sensor and reinstall it, then bring the sensor close to the IBS-M2S WiFi Gateway to re-establish the connection and complete the registration.

ITH-20R-0 Wireless Sensor

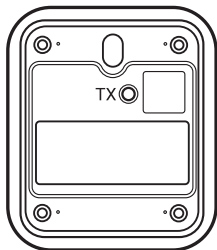

TX Button:

Short press the TX button to send temperature and humidity data to the indoor receiver. After sending successfully, the red light on the transmitter will flash once.

05 APP Installation & Connection



5.1 INKBIRD APP

Search the INKBIRD App from Google Play or App Store to get it for free, or you can scan the QR code left to download it directly.

NOTES:

1. Your iOS devices must be running iOS 12.0 or above to download the app smoothly.
2. Your android devices must be running android 7.1 or above to download the app smoothly.
3. The device supports a 2.4GHz Wi-Fi router only.
4. APP Location Permission Requirement: We need to obtain your location information to discover and add nearby devices. INKBIRD promises to keep your location information strictly confidential. And your location information will only be used for the location function of the App and will not be collected, used, or disclosed to any third party. Your privacy is very important to us. We will abide by relevant laws and regulations and take reasonable security measures to protect your information security.

5.2 Registration

Step1: Registering an account is necessary before using the INKBIRD app for the first time.

Step2: Open the app, select your Country/Region, and a verification code will be sent to you.

Step3: Enter the verification code to confirm your identity, and the registration is complete.

5.3 How to Connect

Open the INKBIRD app and Click “+” on the top right corner to add a device. Then, follow the app instructions to complete the WiFi connection. Note that the device should be as close as possible to the smartphone and router during the connection process.

5.3.1 Open the app, click “+”, and choose the IBS-M2S to start the connection.

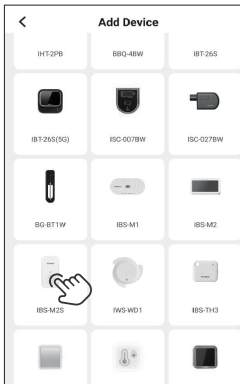

5.3.2 Plug in the gateway, power it on, and click Next Step.



5.3.3 Select a WiFi network to connect, enter the password, and click Next Step.

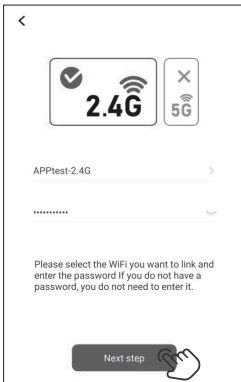

5.3.4 Press and hold the  button until the WiFi indicator light flashes and enters the pairing state, then click Next Step.



5.3.5 The smartphone will automatically scan for the device. Once the device is found, click Next Step.

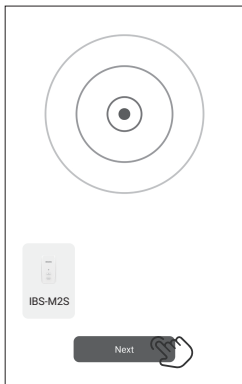

5.3.6 Automatically pairing.

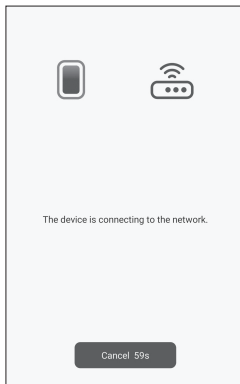

5.3.7 The pairing is successful.



Note: If the pairing fails, unplug the device, restart it again, and repeat the above steps to complete the connection.

5.4 Add ITH-20R-O Wireless sensors

- a) Firstly, plug in the IBS-M2S WiFi Gateway and start it up correctly. Then follow the above steps to establish the App connection. If the app connection has already been completed, skip this step.
- b) Secondly, install the battery of the ITH-20R Wireless sensor , start it up correctly, and put it as close as possible to the IBS-M2S WiFi Gateway.
- c) Add sub-devices through the phone APP, as shown in the figures below. Select the relevant device and click confirm to add it. The sub-device will automatically establish a connection. After adding successfully, the ITH-20R-O Wireless sensor channel number will be displayed.

Note that if adding the device fails, take out the battery of the ITH-20R-O Wireless sensor and repeat steps a~c to complete the addition.

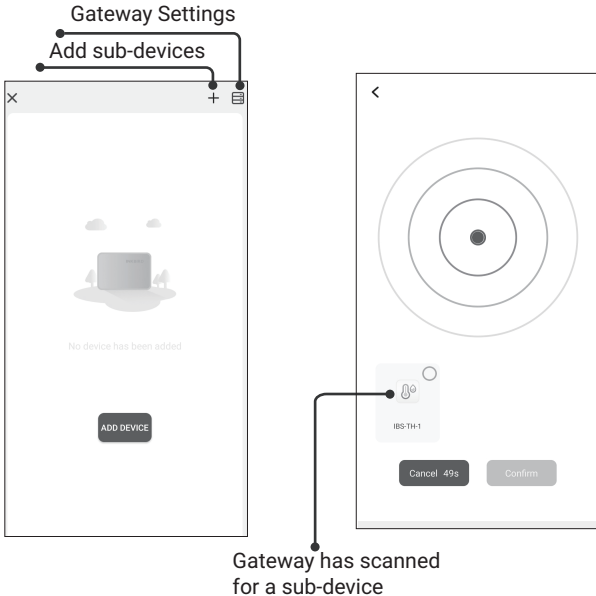

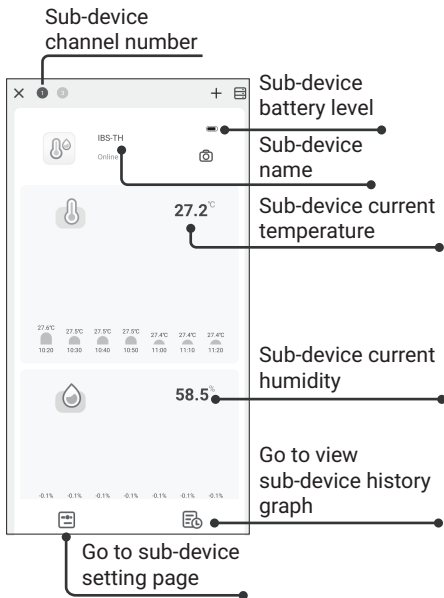

06 *Important Notes/Warnings*

- a) Pay attention to the safe use of electronic products and keep children away.
- b) Please do not disassemble the product if you are not a professional.
- c) Be sure that the sensor is not covered with dust as dust may lead to inaccurate measurements.
- d) Do not use alcohol to clean the sensor.

07 *Troubleshooting Guide*

<i>Issues</i>	<i>Possible Solutions</i>
The gateway cannot connect to the network	<ul style="list-style-type: none">a. Make sure the 2.4GHz WiFi signal is stable, and place the WiFi gateway as close to the router as possible.b. Make sure there are as few barriers as possible between the WiFi gateway and the router.c. Enable Bluetooth and positioning functions, allow the App to obtain location information, and allow the local network (iOS System).

06 *Important Notes/Warnings*

- a) Pay attention to the safe use of electronic products and keep children away.
- b) Please do not disassemble the product if you are not a professional.
- c) Be sure that the sensor is not covered with dust as dust may lead to inaccurate measurements.
- d) Do not use alcohol to clean the sensor.

07 *Troubleshooting Guide*

<i>Issues</i>	<i>Possible Solutions</i>
The gateway cannot connect to the network	<ul style="list-style-type: none">a. Make sure the 2.4GHz WiFi signal is stable, and place the WiFi gateway as close to the router as possible.b. Make sure there are as few barriers as possible between the WiFi gateway and the router.c. Enable Bluetooth and positioning functions, allow the App to obtain location information, and allow the local network (iOS System).

for a Class B digital device, pursuant to Part 15 of the FCC Rules. These limits are designed to provide reasonable protection against harmful interference in a residential installation. This equipment generates, uses, and can radiate radio frequency energy, and if not installed and used in accordance with the instructions, may cause harmful interference to radio communications. However, there is no guarantee that interference will not occur in a particular installation. If this equipment does cause harmful interference to radio or television reception, which can be determined by turning the equipment off and on, the user is encouraged to try to correct the interference by one or more of the following measures:

- Reorient or relocate the receiving antenna.
- Increase the separation between the equipment and receiver.
- Connect the equipment into an outlet on a circuit different from that to which the receiver is connected.
- Consult the dealer or an experienced radio/TV technician for help.

This equipment complies with FCC radiation exposure limits set forth for an uncontrolled environment. This equipment should be installed and operated with a minimum distance of 20cm between the radiator & your body. This transmitter must not be co-located or operating in conjunction with any other antenna or transmitter.

09 *Customer Service*

This item carries a 1-year warranty against defects in either components or workmanship. During this period, products that prove to be defective will, at the discretion of INKBIRD, be either repaired or replaced without charge. For any problems in use, please feel free to contact us at support@ink-bird.com. We will do our best to help you.

INKBIRD TECH.C.L.

support@inkbird.com

Factory address: 6th Floor, Building 713, Pengji Liantang Industrial Area, NO.2 Pengxing Road, Luohu District, Shenzhen, China

Office address: Room 1803, Guowei Building, NO.68 Guowei Road, Xianhu Community, Liantang, Luohu District, Shenzhen, China



V1.0